



## INCASS. LED 4" 14W 220-240V 3000K TONDO

### Typology

LED source with SMD technology and high efficiency chip integrated into a recessed luminaire.  
External driver included in the package.  
Low thickness.

### Features

Aluminium finned body for best heat dissipation.

### Installation

Complete with springs for easy fastening into false ceilings.

### Material

Die-cast aluminium body.



### Characteristic data

Power	14 W	Beam	110°	Dimmable	No	Input	100-240 Vac
Base	Wire	IP	20	Optical compartment IP	43	Flux	1195 lm
Axis	585 cd	PF	0.9	Tc	3000 K	Ra	90
LED Warranty	G5h24	RG	RG0				

### Dimensional characteristics

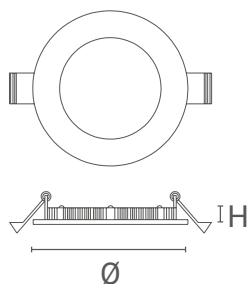

Ø	145 mm
H	27 mm

Cutting hole	125
--------------	-----

## Lighting and photometric features

Beam opening	110°
Flux	1195 lm
Axis	585 cd
CCT nominal colour temperature	3000 K
Colour of the light	Warm light
Colour rendering index	90
Lifespan	50000 h
LED lifespan	L70B20

## Electrical characteristics

Rated power	14 W
Input voltage	100-240 Vac
Frequency	50/60 Hz
Dimmable	No
Power factor (PF)	0.9
Input current	0.67 A
Weighted energy consumption	14 kWh/1000h
Operating temperature	-25°C / +35°C

## Photometry

EuLumDat file on the site

## Other Infotech

Flicker Free	Yes
Light source replaceability	Replaceable light source by a professional.
Control gear replaceability	Non-replaceable control gear.

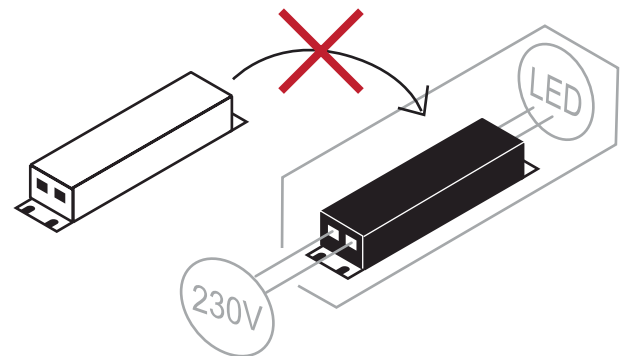
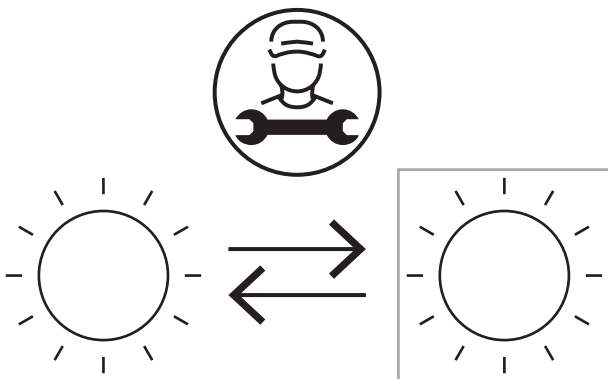

## LED Warranty

G5h24	<p>Full Guarantee 5 years (24h/24h) Without limitations on the duration of use for the first year, provided the observance of the installation conditions.</p>
-------	--

## European Directives

2009/125/EC \* Ecodesign  
2011/65/EU \* RoHS  
2012/19/EU \* RAEE  
2014/30/EU \* EMC  
2014/35/EU \* LVD  
2015/863 \* Amending RoHS  
2017/1369 \* Regulation for Energy Labelling  
2019/2015 \* Regulation for Energy Labelling  
2019/2020 \* Regulation for Ecodesign  
2021/340 \* Amending Reg. Energy Labelling  
2021/341 \* Amending Reg. Ecodesign

## Product standards

CEI EN 55015:2020 (+A11:2020)  
CEI EN 60598-1:2022  
CEI EN 60598-2-5:2016  
CEI EN 61000-3-2:2019 (+A1:2021)  
CEI EN 61000-3-3:2014 (+EC1:2014/+EC2:2016/+A1:2021/+A2:2022)  
CEI EN 61547:2010  
CEI EN 62031:2021 (+A11:2022)  
CEI EN 62471:2010  
IEC/TR 62471-2:2009  
CEI EN 62493:2015  
CEI 34-141:2014

## Logistics data

Item net weight	210 gr
Barcode single item	8011905326784
Number of pieces multiple pack	30
Minimum order quantity	1
Minimum packaging	1 / 30